

CNH



Exclusive Distributor

AHM Multilocations - United States & Canada

2024
MARCH

CONTENTS



UH Farming 1:16	3
UH Farming 1:32	6
UH Farming Keychain	15
Falk 1.5-3 yrs	17
Falk 2-5 yrs	18
Falk 3-7 yrs	19
UH Kids Farming	22
UH Kids Construction	28



Global Agriculture and Construction Brands:



DAVID BROWN 950 Implematic - 1959

UH4997



137 pcs

154 times

600 g / 1.3 lb



21.3 x 11.2 x 13.1 cm

8.4 x 4.4 x 5.2 in

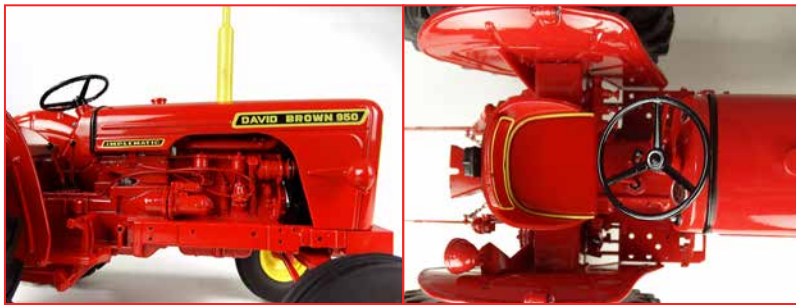

Fordson Power Major Tractor (1958)

UH2640



158 pcs



14 times



553 g / 1.2 lb



21 x 11 x 13 cm

8.3 x 4.3 x 5.1 in

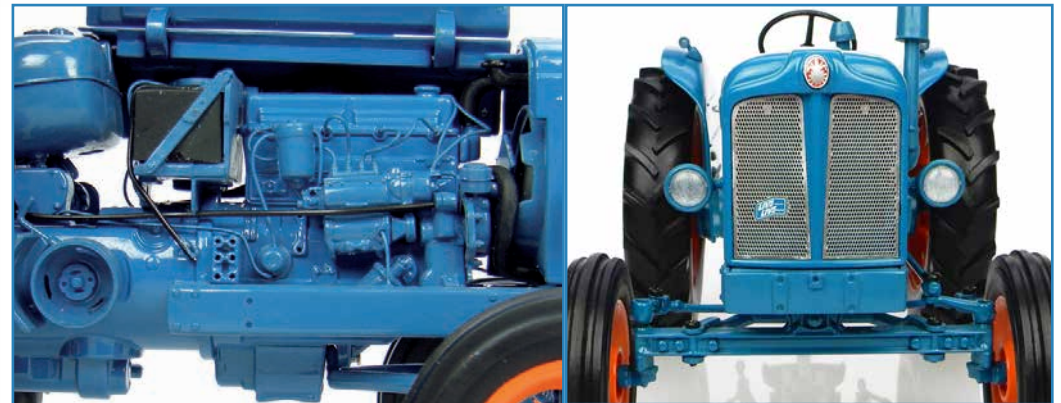

FORDSON DEXTA 1960-1962

UH2898



138 pcs 160 times 445 g / 1.0 lb



18.2 x 10.0 x 11.6 cm
7.2 x 4.0 x 4.6 in



FORDSON SUPER DEXTA

UH2900



137 pcs 165 times 450 g / 1.0 lb



18.2 x 10.0 x 11.6 cm
7.2 x 4.0 x 4.6 in



CASE IH 1394 - 2WD

UH6471



116 pcs 120 times 315 g / .7 lb



14.0 x 7.0 x 8.5 cm

5.5 x 2.8 x 3.3 in



ABOUT THIS MODEL

- 1/ New specific top front hood without air intake grille
- 2/ Specific Hydra shift lettering
- 3/ Case Internatioanal logo
- 4/ Rear standard realistic UH coupling system and adjustable third point linkage



CASE IH 1394 - 4WD

UH6436



115 pcs 87 times 315 g / .7 lb



14.0 x 7.0 x 8.5 cm

5.5 x 2.8 x 3.3 in



ABOUT THIS MODEL

- 1/ New specific top front hood without air intake grille
- 2/ Case logo on the rear window
- 3/ Rear standard realistic UH coupling system & adjustable third point linkage
- 4/ Specific 1394 lettering



CASE IH International 1394

UH6470



116 pcs 120 times 315 g / .7 lb



14.0 x 7.0 x 8.5 cm

5.5 x 2.8 x 3.3 in



CASE IH Maxxum 145 CVX

UH6462



112 pcs 139 times 401 g / .9 lb



16.5 x 7.8 x 9.6 cm

6.5 x 3.1 x 3.8 in

ABOUT THIS MODEL

- 1/ New GPS part
- 2/ New license plate
- 3/ New exhaust pipe
- 4/ New tank, stairs, and rear fender protection
- 5/ New warning light
- 6/ New wiper and wiper location
- 7/ Front and rear roof lights
- 8/ New light and turning signal
- 9/ Front standard realistic UH coupling system adjustable third point linkage



Case IH Axial Flow 2188

UH5269



120 pcs 154 times 1049 g / 2.3 lb



32 x 21.8 x 13.8 cm

12.6 x 8.6 x 5.43 in

ABOUT THIS MODEL

- 1/ All parts are sprayed and not in plastic molding color
- 2/ All the protective grilles are in photoetching metal parts
- 3/ Outside mirror support is movable and in metal
- 4/ Support bar in metal
- 5/ "Axial Flow" lettering is on a raised surface and tampoprinted
- 6/ Engraved floor
- 7/ The ladder can turn
- 8/ Soft plastic protection
- 9/ Clear part tampoprinted
- 10/ Folding ladder
- 11/ Protective part made with soft plastic
- 12/ Small triangle parts are separated pieces

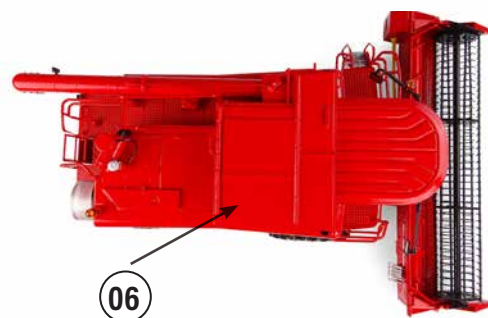
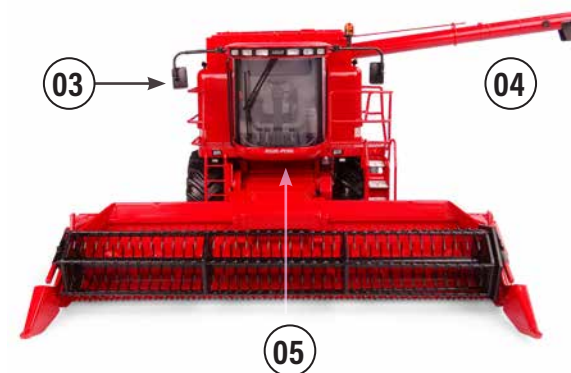

FORD Super Dexta 2000 Diesel

UH6275



78 pcs 56 times 89 g / .2 lb



8.9 x 5.2 x 6.0 cm

3.5 x 2.4 x 2.4 in



ABOUT THIS MODEL

- 1/ Super Dexta emblem made in a separate part in chrome finish with silver printing
- 2/ Photoetched engraved metal grille
- 3/ Tires in rubber with engraved pattern
- 4/ Cushion seat in rubber with blue piping
- 5/ Logo printed in tampon printing
- 6/ Adjustable third point and movable linkage

FORD COUNTY 1474

UH4032



110 pcs 161 times 435 g / 1.0 lb



16.0 x 8.0 x 9.0 cm

6.3 x 3.1 x 3.5 in





1:32

NEW HOLLAND T5.120 Electrocommand 2022

UH6360



98 pcs



87 times



347 g / 0.8 lb



15.4 x 8.4 x 9.7 cm

6.1 x 3.3 x 3.8 in



ABOUT THIS MODEL

- 1/ New stairs
- 2/ New «Natural Flow» side hood design graphic in tampoprinting
- 3/ New model number T5.120
- 4/ Complete new exhaust pipe



02

01



04

03



NEW HOLLAND T6.180 Methane
UH6402



121 pcs 126 times 394 g / .9 lb



17.6 x 7.8 x 9.6 cm
6.9 x 3.1 x 3.8 in



ABOUT THIS MODEL

- 1/ Specific logo
- 2/ New Methane tank, exhaust pipe & stairs
- 3/ "Methane" name engraved on the tank
- 4/ Additional clear lense light
- 5/ New GPS box
- 6/ Additional Methane tank
- 7/ New side hood printing
- 8/ Specific "Powered by Nature" logo



NEW HOLLAND T7.190
UH6363

132 pcs 120 times 477 g / 1.1 lb



16.8 x 7.8 x 11.8 cm
6.6 x 3.1 x 4.6 in



NEW HOLLAND T7.1655
UH6365





137 pcs 104 times 416 g / .9 lb



16.8 x 7.8 x 10.0 cm
6.6 x 3.1 x 3.9 in



ABOUT THIS MODEL

- 1/ New intelli View screen much bigger
- 2/ New step design
- 3/ New model number T7.190
- 4/ New led side lights
- 5/ New low mounted wiper
- 6/ New GPS antenna
- 7/ New outside mirror
- 8/ New led side lights

NEW HOLLAND T7.300

UH6491



140 pcs 161 times 519 g / 1.1 lb



16.5 x 8.8 x 11.5 cm

6.5 x 3.5 x 4.5 in

ABOUT THIS MODEL





- 1/ Front and rear standard realistic UH coupling system adjustable third point linkage
- 2/ Rear foldable warning sign
- 3/ New seats with "Blue Power" & "T7" lettering
- 4/ PLM specific logo
- 5/ New side hood graphic design
- 6/ GPS in a separate part
- 7/ Foldable outside mirror
- 8/ Light with a clear lens
- 9/ Clear lens headlight



NEW



UH 20 Round Hay Bales
UH9750

1 Pack	1 Single Bale
	
270 g / 0.6 lb	11 g / 0.02 lb
	
7.4 x 3.0 x 3.0 in	1.5 x 2.0 x 1.4 in



20 Round Hay Bales

CASE IH Magnum 380 CVX

UH5821



14 pcs 20 times 27 g / .06 lb



4.5 x 2.0 x 2.4 cm

1.8 x 0.8 x 0.94 in



Case IH Magnum 380 «Black Beauty»

UH5883



8 pcs 36 times 30 g / .07 lb



4.4 x 2.2 x 2.5 cm

1.7 x 0.9 x 1.0 in



2000
LIMITED EDITION
PCS





CASE IH Axial Flow 9240

UH5834



8 pcs



24 times



40 g / 1 lb



5.1 x 4.7 x 2.0 cm

2.0 x 1.9 x 0.8 in



CASE CE Push-Along Tractor with Trailer, Rake & Shovel

FA297C



91.4 x 33.0 x 38.1 cm

36.0 x 13.0 x 15.0 in



CASE
CONSTRUCTION

CASE IH Push-Along Tractor with Trailer, Rake & Shovel

FA238C



91.4 x 33.0 x 38.1 cm

36.0 x 13.0 x 15.0 in



CASE IH
AGRICULTURE

NEW HOLLAND T3.315 Push-Along Tractor with Trailer, Rake & Shovel

FA280C



91.4 x 33.0 x 38.1 cm

36.0 x 13.0 x 15.0 in



NEW HOLLAND

NEW HOLLAND Girly Push-Along Tractor with Trailer, Rake & Shovel

FA288C



91.4 x 33.0 x 38.1 cm

36.0 x 13.0 x 15.0 in



CASE IH Maxxum CVX 130 Pedal Tractor with Front Loader & Trailer

FA961AM



40.6 x 40.6 x 40.6 cm
32.0 x 16.0 x 16.0 in



CASE IH Maxxum CVX 130 Pedal Tractor with Trailer

FA961B



132.1 x 45.7 x 53.3 cm
52.0 x 18.0 x 21.0 in



CASE CE Pedal Backhoe with Rear Excavator & Trailer

FA967N



180 x 46 x 53 cm
71 x 18 x 21 in



NEW HOLLAND T6 Pedal Tractor with Trailer

FA3080AB



132.1 x 43.2 x 53.3 cm
52.0 x 17.0 x 21.0 in



**CASE IH Puma CVX240
Pedal Tractor with Trailer**

FA996AB



172.7 x 58.4 x 66.0 cm

68.0 x 23.0 x 26.0 in



**CASE IH Puma CVX240 Pedal Tractor
with Trailer & Front Loader**

FA996AM



205.7 x 58.4 x 71.1 cm

81.0 x 23.0 x 28.0 in

**NEW HOLLAND Pedal Tractor
with Trailer**

FA3090B



162.6 x 58.4 x 66.0 cm

64.0 x 23.0 x 26.0 in



**NEW HOLLAND T8 Pedal Tractor
with Backhoe with Excavator & Maxi tilt Trailer**

FA3090W



223.5 x 58.4 x 76.2 cm

88.0 x 23.0 x 30.0 in

**CASE CE Backhoe
with Excavator & Maxi Tilt Trailer**

FA997W



226.1 x 58.4 x 81.3 cm

89.0 x 23.0 x 32.0 in



CASE IH Axial Combine

UHK1128



30.5 x 22.9 x 22.9 cm

12.0 x 9.0 x 9.0 in



CASE IH Magnum

UHK1133



30.5 x 26.7 x 24.0 cm

12.0 x 10.5 x 9.0 in



Smaller Size Plushes:
UHK1149 & UHK1150

NEW



AVAILABLE
JUNE 2024

CASE IH Magnum

UHK1149



15.2 x 12.7 x 12.7 cm

6.0 x 5.0 x 5.0 in



CASE IH Magnum

UHK1150



15.2 x 12.7 x 12.7 cm

6.0 x 5.0 x 5.0 in



NEW HOLLAND T7 Tractor Blue

UHK1154



26.0 x 23.5 x 23.0 cm

10.2 x 9.3 x 9.1 in



NEW HOLLAND T7 Tractor Blue Power

UHK1155



26.0 x 23.5 x 23.0 cm

10.2 x 9.3 x 9.1 in



Smaller Size Plushes:
UHK1157 & UHK1156

AVAILABLE
JUNE 2024



NEW

NEW HOLLAND T7 Small - Pink

UHK1157



15.2 x 12.7 x 12.7 cm

6.0 x 5.0 x 5.0 in



NEW HOLLAND T7 Small - Blue

UHK1156



15.2 x 12.7 x 12.7 cm

6.0 x 5.0 x 5.0 in



PLUSHES



NEW HOLLAND Mascot BASIL

UHK1138



22.0 x 26.0 x 6.0 cm

8.7 x 10.2 x 2.4 in



to Contents



NEW HOLLAND Forage Cruiser

UHK1158



35.6 x 30.5 x 22.9 cm

14.0 x 12.0 x 9.0 in



AVAILABLE
JUNE 2024



Farm Line

NEW HOLLAND Combine

UHK1120



35.5 x 25.5 x 20 cm

14 x 10 x 8 in



CASE Backhoe

UHK1110



48.0 x 21.0 x 26.0 cm

18.9 x 8.3 x 10.2 in



CASE Excavator

UHK1111



30.0 x 22.0 x 24.0 cm

11.8 x 8.66 x 9.45 in



CASE Bulldozer

UHK1116



30.0 x 20.0 x 20.0 cm

11.8 x 7.9 x 7.9 in



CASE Skid Loader

UHK1117



30.0 x 21.0 x 20.0 cm

11.8 x 8.3 x 7.9 in



CNH INDUSTRIAL

PRODUCTS UNDER LICENSE

